

深圳市华科百誉科技有限公司

SPECIFICATION FOR LCD MODULE

Customer : _____
Product Model: HK-035HQ5402
Sample code: _____

Designed by	Checked by	Approved by

Final Approval by Customer

<input type="checkbox"/> LCM Machinery OK Checked By _____ <input type="checkbox"/> LCM Display OK Checked By _____	<input type="checkbox"/> LCM OK <input type="checkbox"/> NG , Problem survey: Approved By _____
--	---

※The specification of "TBD" should refer to the measured value of sample . If there is difference between the design specification and measured value, we naturally shall negotiate and agree to solution with customer.

Contents

1. General Specifications	1
2. Pin Assignment	2
3. Operation Specifications	4
3.1. Absolute Maximum Ratings	4
3.1.1. Typical Operation Conditions.....	4
3.1.2. Backlight Driving Conditions	4
3.2. Power Sequence	5
3.3. Timing Characteristics	5
3.3.1. Serial mode timing &clock.....	5
3.3.2. Serial Transmission mode.....	6
3.3.3. Data Input Timing.....	7
3.3.4. Data Input Format.....	8
4. Optical Specifications	9
5. Reliability Test Items	13
6. General Precautions	14
6.1. Safety	14
6.2. Handling	14
6.3. Static Electricity	14
6.4. Storage.....	14
6.5. Cleaning.....	14
7. Mechanical Drawing.....	15

1. General Specifications

No.	Item	Specification	Remark
1	LCD size	3.5 inch(Diagonal)	
2	Driver element	a-Si TFT active matrix	
3	Resolution	320 × 3(RGB) × 240	
4	Display mode	Normally White, Transmissive	
5	Dot pitch	219(W) × 219(H) um	
6	Active area	70.08(W) × 52.56 (H) mm	
7	Module size	76.9(W) × 64 (H) × 3.26(D) mm	Note 1
8	Surface treatment	Anti-Glare	
9	Color arrangement	RGB-stripe	
10	Interface	Digital	
11	Backlight power consumption	TBD	
12	Panel power consumption	TBD	
13	Weight	TBD	

Note 1: Refer to Mechanical Drawing.

2. Pin Assignment

1	GLED	GND for LED
2	GLED	GND for LED
3	VLED	Power for LED
4	VLED	Power for LED
5	XR	TP controller
6	YD	TP controller
7	NC	No connect
8	RESET	Reset
9	CS	Serial data enable
10	SCK	Serial clk
11	SDI	Serial data
12	B0	Blue data(LSB)
13	B1	Blue data
14	B2	Blue data
15	B3	Blue data
16	B4	Blue data
17	B5	Blue data
18	B6	Blue data
19	B7	Blue data(MSB)
20	G0	Green data(LSB)
21	G1	Green data
22	G2	Green data
23	G3	Green data
24	G4	Green data
25	G5	Green data
26	G6	Green data
27	G7	Green data(MSB)
28	R0	Red data(LSB)
29	R1	Red data
30	R2	Red data

31	R3	Red data
32	R4	Red data
33	R5	Red data
34	R6	Red data
35	R7	Red data(MSB)
36	HS	Horizontal synchronous signal
37	VS	Vertical synchronous signal
38	CLK	Data clk
39	NC	No connect
40	NC	No connect
41	VDD	Digital power supply(+3.3V)
42	VDD	Digital power supply(+3.3V)
43	XL	TP controller
44	YU	TP controller
45	NC	No connect
46	NC	No connect
47	NC	No connect
48	SEL2	No connect
49	SEL1	No connect
50	SEL0	No connect
51	NC	No connect
52	DE	Data enabling signal
53	GND	Ground
54	GND	Ground

SEL 2-0: Define the input interface mode.

SEL2	SEL1	SEL0	Format	Operating Frequency
0	0	0	Parallel-RGB data format (only support stripe type color filter)	6.5MHz
0	0	1	Serial-RGB data format	19.5MHz
0	1	0	CCIR 656 data format (640RGB)	24.54MHz
0	1	1	CCIR 656 data format (720RGB)	27MHz
1	0	0	YUV mode A data format (Cr-Y-Cb-Y)	24.54MHz
1	0	1	YUV mode A data format (Cr-Y-Cb-Y)	27MHz
1	1	0	YUV mode B data format (Cb-Y-Cr-Y)	27MHz
1	1	1	YUV mode B data format (Cb-Y-Cr-Y)	24.54MHz

Operation Specifications

2.1. Absolute Maximum Ratings

(Note 1)

Item	Symbol	Values		Unit	Remark
		Min.	Max.		
Supply voltage	V _{DD}	-0.3	5.0	V	
Operation Temperature	T _{OP}	-20	70	°C	
Storage Temperature	T _{ST}	-30	80	°C	
LED Reverse Voltage	V _R	-	5	V	Each LED Note 2
LED Forward Current	I _F	-	20	mA	Each LED

Note 1: The absolute maximum rating values of this product are not allowed to be exceeded at any times. Should a module be used with any of the absolute maximum ratings exceeded, the characteristics of the module may not be recovered, or in an extreme case, the module may be permanently destroyed.

Note 2: V_R Conditions: Zener Diode 20mA

2.1.1. Typical Operation Conditions

Item	Symbol	Values			Unit	Remark
		Min.	Typ.	Max.		
Power voltage	DV _{DD}	3.0	3.3	3.6	V	Note 2
	AV _{DD}	5.3	6	6.6	V	
	V _{GH}	13	16.0	16.7	V	
	V _{GL}	-7	-10	-11	V	
Input signal voltage	V _{COM}	3.0	3.8	4.7	V	
Input logic high voltage	V _{IH}	0.7 DV _{DD}	-	DV _{DD}	V	Note 3
Input logic low voltage	V _{IL}	0	-	0.3 DV _{DD}	V	

2.1.2. Backlight Driving Conditions

Item	Symbol	Values			Unit	Remark
		Min.	Typ.	Max.		
Voltage for LED backlight	V _L	--	19.2	21	V	Note 1
Current for LED backlight	I _L	--	20	25	mA	
LED life time	-	-	20,000	-	Hr	Note 2

Note 1: The LED Supply Voltage is defined by the number of LED at Ta=25°C and I_L=20mA.

Note 2: The "LED life time" is defined as th

e module brightness decrease to 50% original brightness at Ta=25°C and I_L=20mA. The LED lifetime could be decreased if operating I_L is larger than 20mA.

LED CIRCUIT

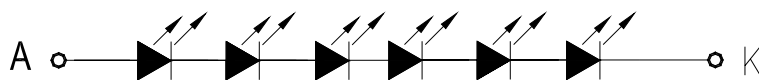

2.2. Power Sequence

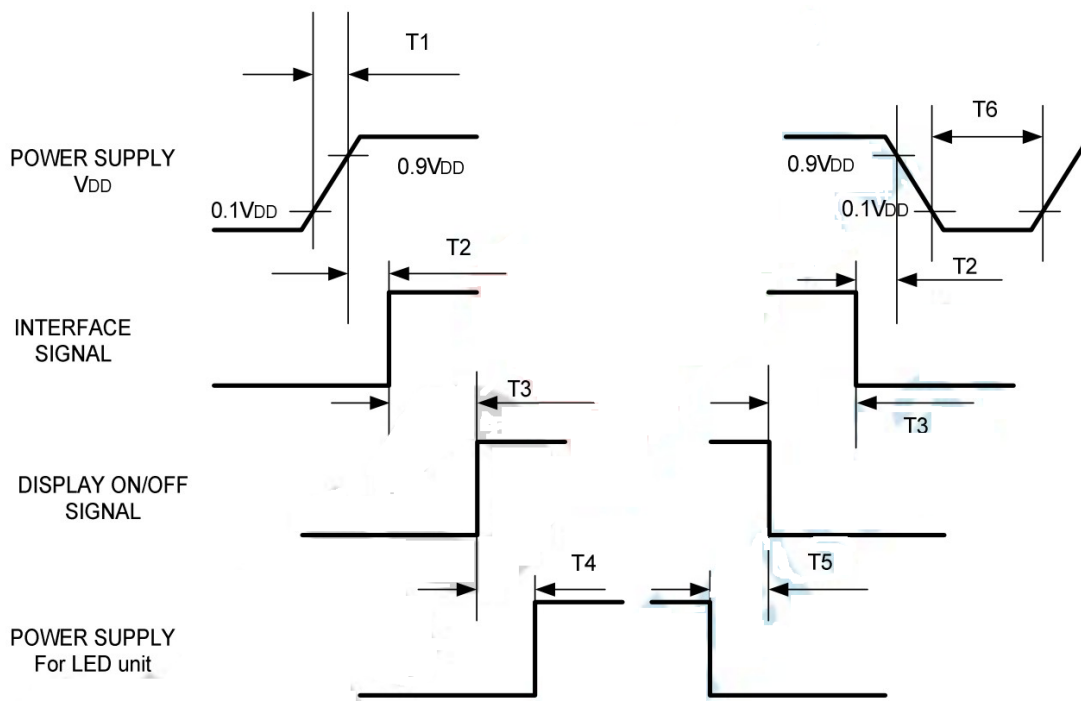

Symbol	Specification	Symbol	Specification
T1	$0 \leq T1 \leq 10\text{msec}$	T4	$160\text{msec} \leq T4$
T2	$0 \leq T2 \leq 10\text{msec}$	T5	$160\text{msec} \leq T5$
T3	$0 \leq T3 \leq 10\text{msec}$	T6	$1\text{msec} \leq T6$

2.3. Timing Characteristics

2.3.1. Serial mode timing & clock

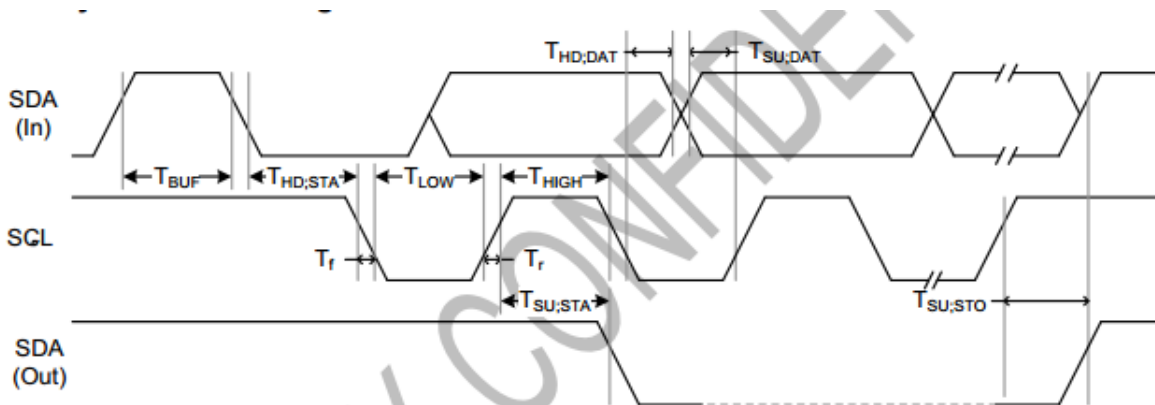

3-Wire Timing Diagram

3-wire serial communication AC timing						
Serial clock	Tspck	320	-	-	ns	
SPCK pulse duty		40	50	60	%	Tckh / Tspck
Serial data setup time	Tisu	120	-	-	ns	
Serial data hold time	Tihd	120	-	-	ns	
Serial clock high/low	Tckh/l	120	-	-	ns	
Chip select distinguish	Tcd	1	-	-	us	
SPENB to VSD	Tcv	1	-	-	us	
SPENB input setup time	Teck	150	-	-	ns	
SPENB input hold time	Tcke	150	-	-	ns	

2.3.2. Serial Transmission mode

3-Wire Serial Port Interface (Default Register Map)

3-Wire Command Format

NT39016 uses the 3-wire serial port as communication interface for all the function and parameter setting. 3-Wire communication can be bi-directional controlled by the "R/W" bit in address field. NT39016 3-Wire engine act as a "slave mode" for all the time, and will not issue any command to the 3-Wire bus itself. Under read mode, 3-Wire engine will return the data during "Data phase". The returned data should be latched at the rising edge of SPCK by external controller. Data in the "Hi-Z phase" will be ignored by 3-Wire engine during write operation, and should be ignored during read operation also. During read operation, external controller should float SPDA pin under "Hi-Z phase" and "Data phase". Refer to the section of "3-Wire Timing Diagram" for the detail timing, please.

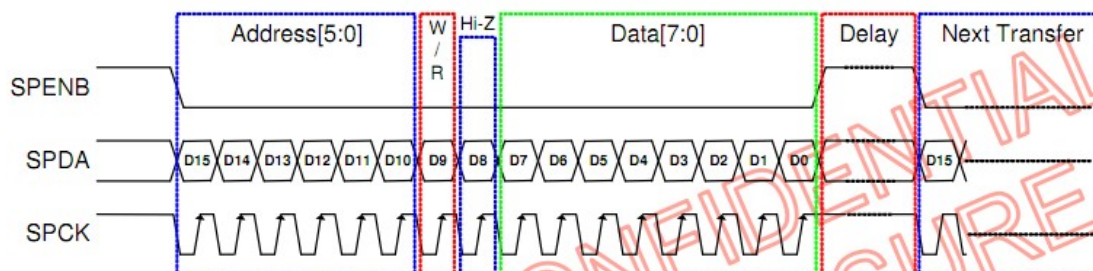

3-Wire Command Format:

Bit	Description
D15-D10	Register Address [5:0].
D9	W/R control bit. "1" for Write; "0" for Read
D8	Hi-Z bit during read mode. Any data within this bits will be ignored during write mode
D7-D0	Data for the W/R operation to the address indicated by Address phase

3-Wire Writer Format:

MSB															LSB
D15	D14	D13	D12	D11	D10	D9	D8	D7	D6	D5	D4	D3	D2	D1	D0
Register Address [5:0]						1	X	DATA (Issue by external controller)							

3-Wire Read Format:

MSB															LSB
D15	D14	D13	D12	D11	D10	D9	D8	D7	D6	D5	D4	D3	D2	D1	D0
Register Address [5:0]						0	Hi-Z	DATA (Issue by NT39016)							

2.3.3. Data Input Timing

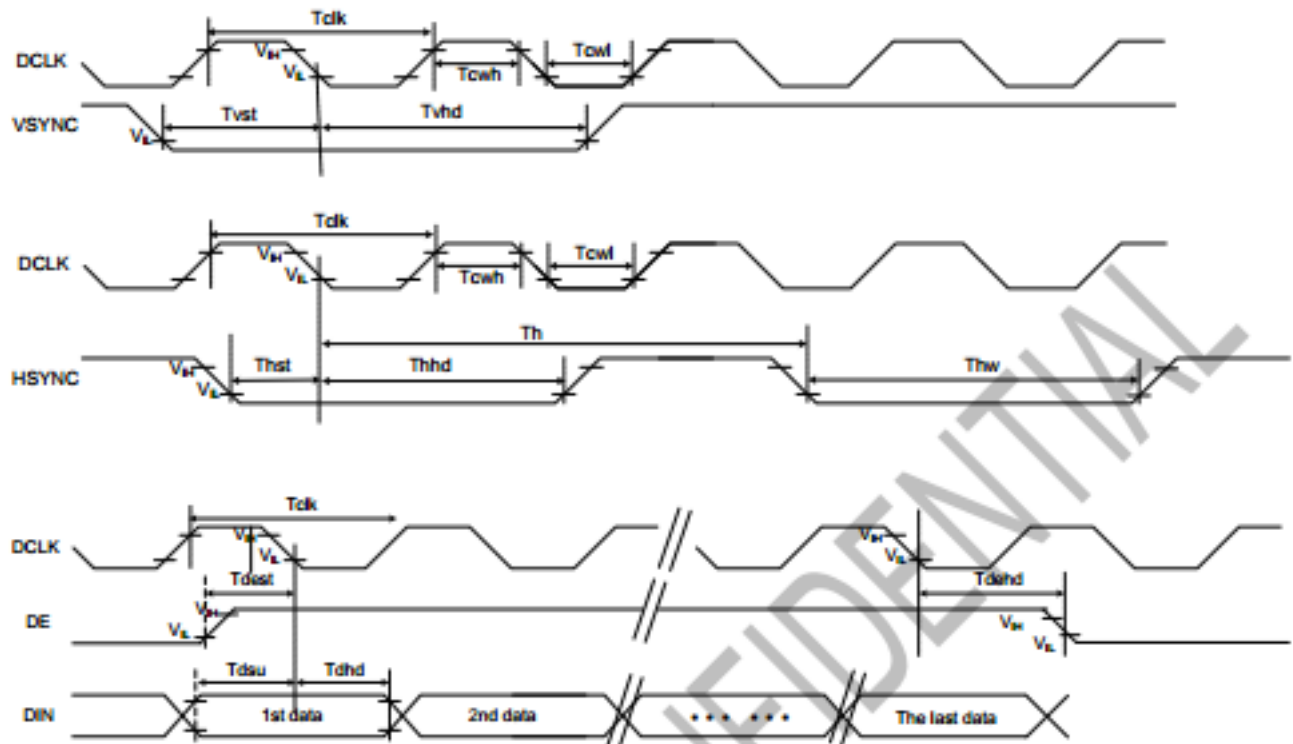

Item	Symbol	Min.	Typ.	Max.	Unit	Conditions
CLK Pulse Duty	T_{clk}	40	50	60	%	
HSYNC Width	T_{hw}	2	-	-	DCLK	
HSYNC Period	T_h	55	60	65	us	
VSYNC Setup Time	T_{dst}	12	-	-	ns	
VSYNC Hold Time	T_{vhd}	12	-	-	ns	
HSYNC Setup Time	T_{hst}	12	-	-	ns	
HSYNC Hold Time	T_{hhd}	12	-	-	ns	
Data Setup Time	T_{dsu}	12	-	-	ns	
Data Hold Time	T_{dhd}	12	-	-	ns	
DE Setup Time	T_{dst}	12	-	-	ns	
DE Hold Time	T_{dhd}	12	-	-	ns	

```
void Set_OTP_Register ()
{
    Write(Command,0x01); //The parameter should be adjusted by the customer
    Write(Data, ID); //ID= 0x01, ID2= 0x02, ID3= 0x03
}

void Check_OTP_Program_Time()
{
    Write(Command,0x69); //The parameter should be adjusted by the customer;
    Read(Data, IDOTPTIME); //MF OTPTIME= 0x6A, MF OTPTIME= 0x6A
                            //DS OTPTIME= 0x6B
}

void OTP_Program_Write()
{
    Write(Command,0x60); //OTP write function enable
    Write(Data,0x46);
    Write(Command,0x65); // The parameter should be adjusted by the customer;
    Write(Data,0x31); // ID ACK= 0x31, ID2 ACK= 0x32, ID3 ACK= 0x33
}

void Check_Program_Result ()
{
    Write(Command,0x01); // The parameter should be adjusted by the customer
    Read(Data, ID); // ID= 0x01, ID2= 0x02, ID3= 0x03
}
}
```

2.3.4. Data Input Format

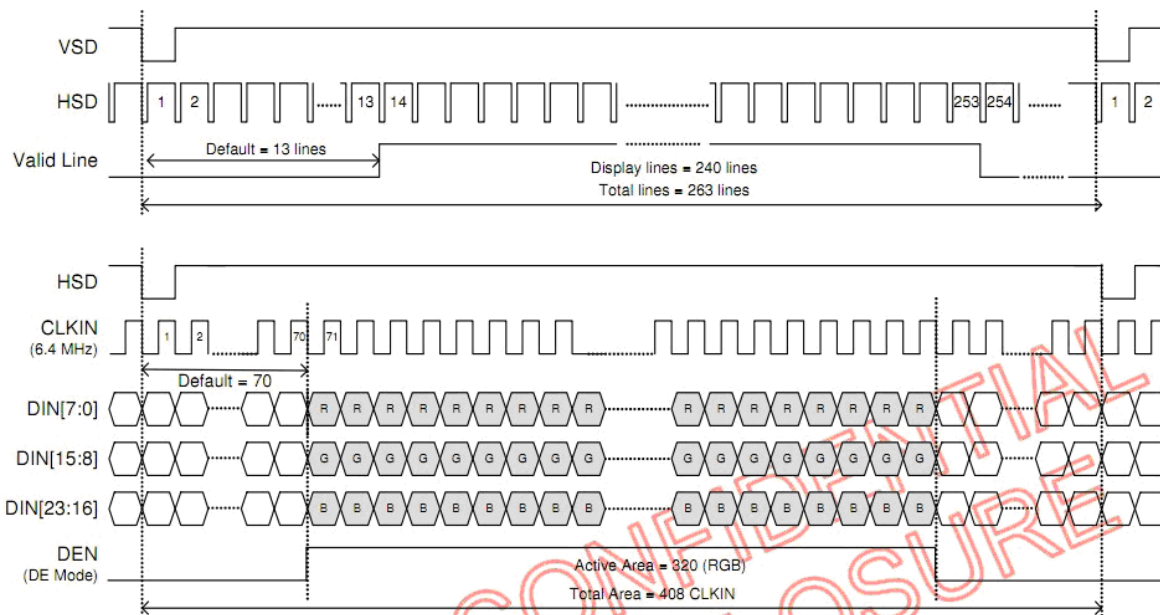

Parameter	Symbol	Min.	Typ.	Max.	Unit	Conditions
CLKIN frequency	Fclk	6.1	6.4	8.0	MHz	VDD = 3.0 ~3.6V
CLKIN cycle time	Tclk	125	156	164	ns	
CLKIN pulse duty	Tcwh	40	50	60	%	Tclk
Time that HSD to 1'st data input(NTSC)	Ths	40	70	255	CLKIN	DDLTY =70, Offset = 0 (fixed)

3. Optical Specifications

Item	Symbol	Condition	Values			Unit	Remark
			Min.	Typ.	Max.		
Viewing angle (CR≥ 10)	θ_L	$\Phi=180^\circ$ (9 o'clock)	-	80	-	degree	Note 1
	θ_R	$\Phi=0^\circ$ (3 o'clock)	-	80	-		
	θ_T	$\Phi=90^\circ$ (12 o'clock)	-	80			
	θ_B	$\Phi=270^\circ$ (6 o'clock)	-	80			
Response time	T_{ON}	Normal $\theta=\Phi=0^\circ$	-	10	20	msec	Note 3
	T_{OFF}		-	10	20	msec	Note 3
Contrast ratio	CR		500	700	-	-	Note 4
Color chromaticity	W_X		0.26	0.31	0.36	-	Note 2 Note 5
	W_Y		0.28	0.33	0.38	-	Note 6
Luminance	L		-	350	-	cd/m ²	Note 6
Luminance uniformity	Y_U		-	70	75	-	%

Test Conditions:

1. $V_{DD}=3.3V$, $I_L=20mA$ (Backlight current), the ambient temperature is $25^\circ C$.
2. The test systems refer to Note 2.

Note 1: Definition of viewing angle range

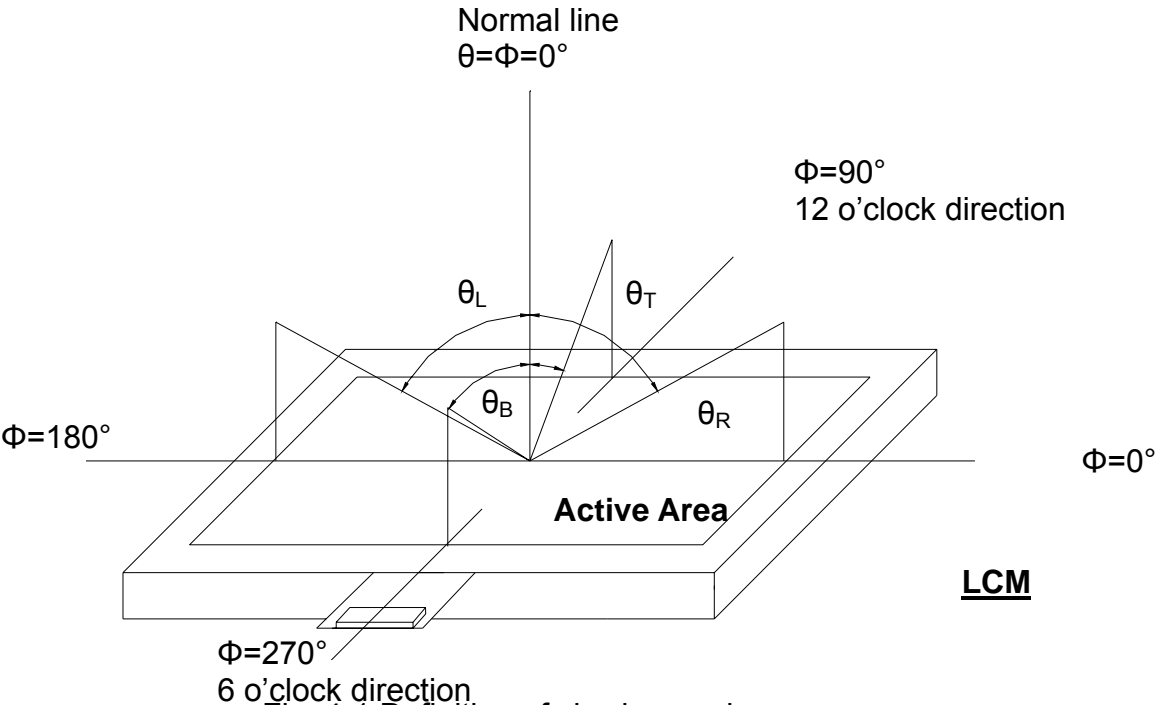

Fig. 4-1 Definition of viewing angle

Note 2: Definition of optical measurement system.

The optical characteristics should be measured in dark room. After 30 minutes operation, the optical properties are measured at the center point of the LCD screen. (Response time is measured by Photo detector TOPCON BM-7, other items are measured by BM-5A/Field of view: 1° /Height: 500mm.)

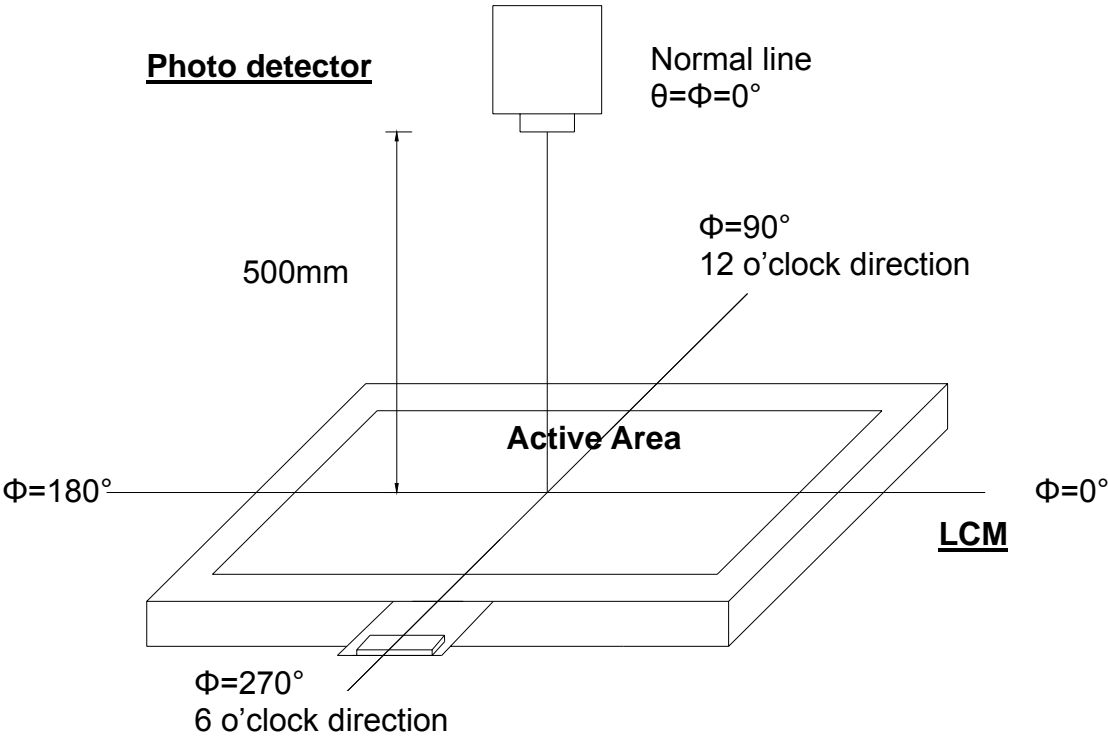

Fig. 4-2 Optical measurement system setup

Note 3: Definition of Response time

The response time is defined as the LCD optical switching time interval between "White" state and "Black" state. Rise time (T_{ON}) is the time between photo detector output intensity changed from 90% to 10%. And fall time (T_{OFF}) is the time between photo detector output intensity changed from 10% to 90%.

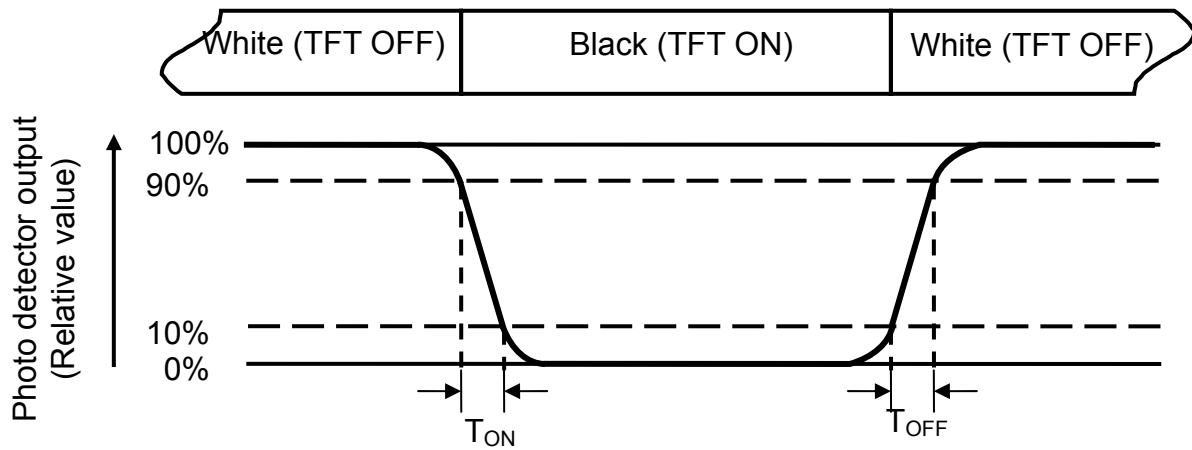

Fig. 4-3 Definition of response time

Note 4: Definition of contrast ratio

$$\text{Contrast ratio (CR)} = \frac{\text{Luminance measured when LCD on the "White" state}}{\text{Luminance measured when LCD on the "Black" state}}$$

Note 5: Definition of color chromaticity (CIE1931)

Color coordinates measured at center point of LCD.

Note 6: All input terminals LCD panel must be ground while measuring the center area of the panel. The LED driving condition is $I_L=120\text{mA}$.

Note 7: Definition of Luminance Uniformity

Active area is divided into 9 measuring areas (Refer to Fig. 4-4).Every measuring point is placed at the center of each measuring area.

$$\text{Luminance Uniformity (Yu)} = \frac{B_{min}}{B_{max}}$$

L-----Active area length W----- Active area width

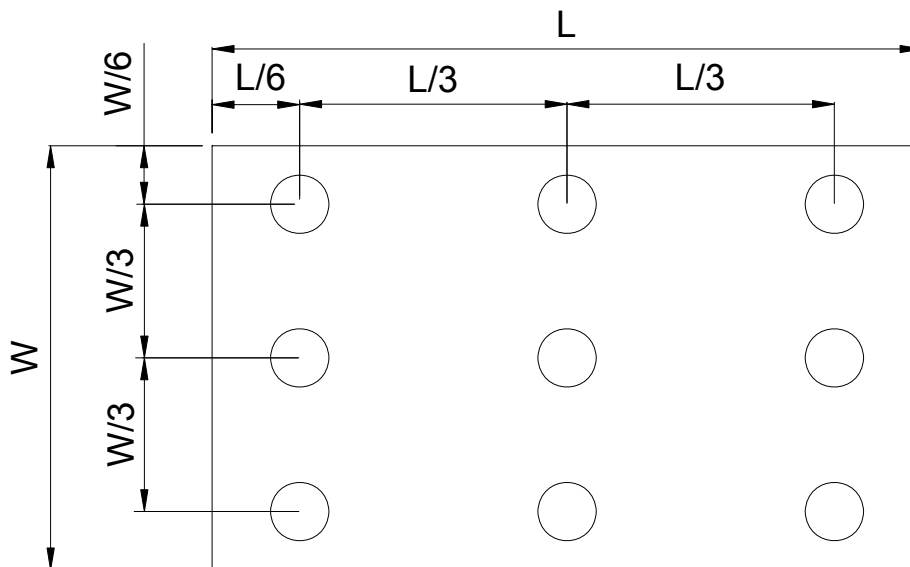

Fig. 4-4 Definition of measuring points

B_{max} : The measured maximum luminance of all measurement position.

B_{min} : The measured minimum luminance of all measurement position.

5. General Precautions

5.1. Safety

Liquid crystal is poisonous. Do not put it in your mouth. If liquid crystal touches your skin or clothes, wash it off immediately by using soap and water.

5.2. Handling

1. The LCD panel is plate glass. Do not subject the panel to mechanical shock or to excessive force on its surface.
2. The polarizer attached to the display is easily damaged. Please handle it carefully to avoid scratch or other damages.
3. To avoid contamination on the display surface, do not touch the module surface with bare hands.
4. Keep a space so that the LCD panels do not touch other components.
5. Put cover board such as acrylic board on the surface of LCD panel to protect panel from damages.
6. Transparent electrodes may be disconnected if you use the LCD panel under environmental conditions where the condensation of dew occurs.
7. Do not leave module in direct sunlight to avoid malfunction of the ICs.

5.3. Static Electricity

1. Be sure to ground module before turning on power or operating module.
2. Do not apply voltage which exceeds the absolute maximum rating value.

5.4. Storage

1. Store the module in a dark room where must keep at $25\pm 10^{\circ}\text{C}$ and 65%RH or less.
2. Do not store the module in surroundings containing organic solvent or corrosive gas.
3. Store the module in an anti-electrostatic container or bag.

5.5. Cleaning

1. Do not wipe the polarizer with dry cloth. It might cause scratch.
2. Only use a soft sloth with IPA to wipe the polarizer, other chemicals might permanent damage to the polarizer.

