

深圳市华科百誉科技有限公司

APPROVAL SHEET

承认书

Customer 客户名称	
Part NO. 产品型号	HK-T090B-B1
Product type 产品内容	Mode: Transmissive type .Normally white. TFT LCD Module LCD Module: Graphic 800RGB*480Dot-matrix
Remarks 备注栏	<input type="checkbox"/> APPROVAL FOR SEPCIFICATIONS ONLY <input checked="" type="checkbox"/> APPROVAL FOR SEPCIFICATIONS AND SAMPLE
Signature by Customer: 客户确认签章	

Issued by	Checked by	Approved by

1. PHYSICAL DATA

Item	Contents	Unit
LCD type	TFT TRANSMISSIVE	---
Viewing direction	6	o'clock
Module size (W×H×T)	210.7× 126.4 × 3.5	mm ³
Active area(W×H)	198×117.7	mm ²
Number of dots(W×H)	800*RGB* × 480	dots
Pixel Pitch(W×H))	0.2475xRGB×0.2327	mm
Driver IC	EK9713	---
Colors	16.7M	---
Backlight Type	18 white leds 9.6V /120mA	---
Interface Type	RGB	---

2. BLOCK DIAGRAM

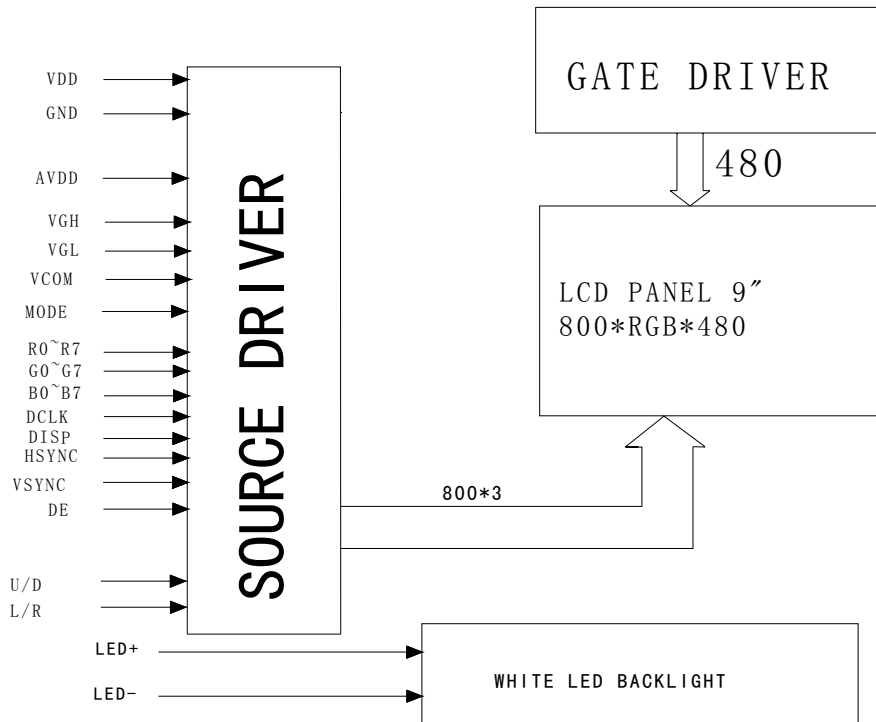

3. Mechanical Dimension

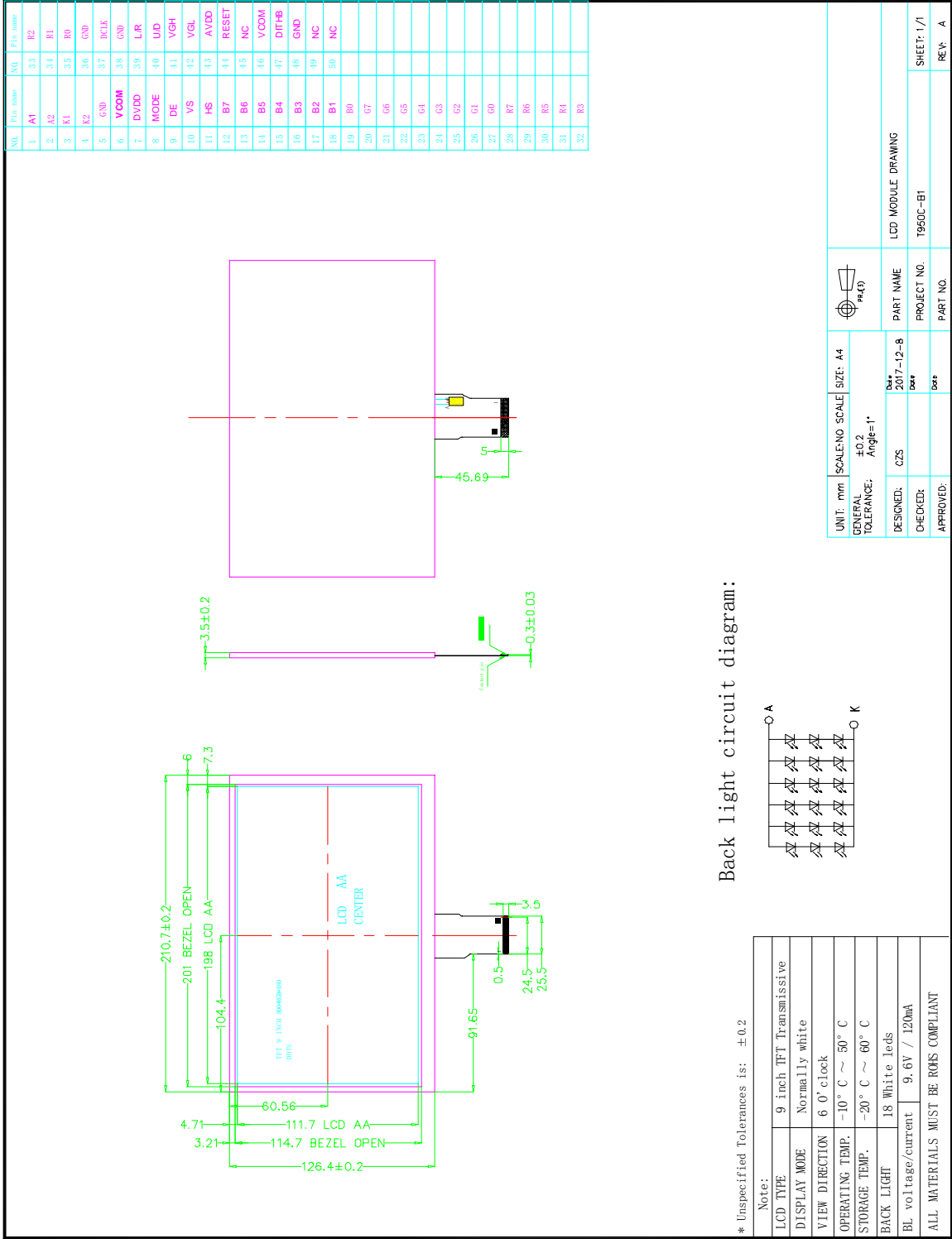

Back light circuit diagram:

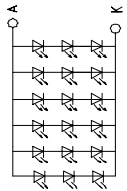

4. Pin Descriptions

Pin No.	Symbol	Functional
1	LED A	LED Anode
2	LED A	LED Anode
3	LED K	LED Cathode
4	LED K	LED Cathode
5	GND	Digital Ground
6	VCOM	For external VCOM DC input
7	DVDD	Digital Power
8	MODE	DE/SYNC mode select MODE=H: DE mode(normally pull high) MODE=L: HSD/VSD mode
9	DE	Data enable signal
10	VSYNC	Vertical sync input.Negative polarity
11	HSYNC	Horizontal sync input.Negative polarity
12~19	B7~B0	Blue data Input
20~27	G7~G0	Green data Input
28~35	R7~R0	Red data Input
36	GND	Digital Ground
37	DCLK	Clock input
38	GND	Digital Ground
39	L/R	Source right or left sequence control SHLR=H: right shift, Left → Right SHLR=L: left right, Right → Left
40	U/D	Gate up or down scan control UPDN=H: up shift, Down → Up UPDN=L: down shift, Up → Down
41	VGH	Positive Power for TFT
42	VGL	Negative Power for TFT
43	AVDD	Analog Power
44	RSTB	Global reset pin.Active low to enter reset state Suggest to connecting with an RC reset circuit for stability. Normally pull high. (RC circuit :R=10K Ω , C=1uF)
45	NC	Not connect
46	VCOM	For external VCOM DC input
47	DITHB	Dithering setting
48	GND	Digital Ground
49	NC	Not connect
50	NC	Not connect

5. ABSOLUTE MAXIMUM RATINGS

5.1 (GND=AGND=0V)

Parameter	Symbol	Min	Max	Unit
Power supply1	V _{DD}	1.8	3.6	V
Power supply2	A _v dd	6.5	13.85	V
Operating temperature	T _{OPR}	-10	50	°C
Storage temperature	T _{STG}	-20	60	°C

5.2 Input driver voltage for LCD

parameter	Typ	Unit	remark
VGH	18	V	Temp:25 +/-2
VGL	-5	V	
AVDD	9.6	V	
VCOM	4.0	V	

Note: Please adjust Vcom to make the flicker level be minimum

6. DC ELECTRICAL CHARACTERISTICS FOR RGB

Parameter	Symbol	Condition	Min.	Typ.	Max.	Unit
Low level input voltage	Vil	For the digital circuit	0	-	0.3×VDD	V
High level input voltage	Vih	For the digital circuit	0.7×VDD	-	VDD	V
Input leakage current	Ii	For the digital circuit	-	-	±1	μA
High level output voltage	Voh	Ioh= -400 μA	VDD-0.4	-	-	V
Low level output voltage	Vol	Iol= +400 μA	-	-	VSS+0.4	V
Pull low/high resistor	Ri	For the digital input pin @ VDD=3.3V	200K	250K	300K	ohm
Digital Operation current	Idd	Fclk=50 MHz, FLD=48KHz, VDD=3.3V	-	14	18	mA
Digital Stand-by current	Ist1	Clock and all functions are stopped	-	10	50	μA
Analog Operating Current	Idda	No load, Fclk=50MHz, FLD=48KHz @ VDDA=10V, V1=8V, V14=0.4V	-	7	12	mA
Analog Stand-by current	Ist2	No load, Clock and all functions are stopped	-	10	50	μA
Input level of V1 ~ V7	Vref1	Gamma correction voltage input(Cascade Mode)	0.4×VDDA	-	VDDA-1	V
Input level of V8 ~ V14	Vref2	Gamma correction voltage input(Cascade Mode)	VSSA+1	-	0.6×VDDA	V
Input level of V1 ~ V7	Vref3	Gamma correction voltage input(Dual Gate Mode)	0.4×VDDA	-	VDDA-0.1	V
Input level of V8 ~ V14	Vref4	Gamma correction voltage input(Dual Gate Mode)	VSSA+0.1	-	0.6×VDDA	V
Output Voltage deviation	Vod1	Vo = VSSA+0.1V ~ VSSA+0.5V and Vo = VDDA-0.5V ~ VDDA-0.1V	-	±20	±35	mV
Output Voltage deviation	Vod2	Vo = VSSA+0.5V ~ VDDA-0.5V	-	±15	±20	mV
Output Voltage Offset between Chips	Voc	Vo = VSSA+0.5V ~ VDDA-0.5V	-	-	±20	mV
Dynamic Range of Output	Vdr	SO1 ~ SO1200	0.1	-	VDDA-0.1	V
Sinking Current of Outputs	IOLy	SO1 ~ SO1200; Vo=0.1V v.s 1.0V , VDDA=13.5V	80	-	-	uA
Driving Current of Outputs	IOHy	SO1 ~ SO1200; Vo=13.4V v.s 12.5V , VDDA=13.5V	80	-	-	uA
Resistance of Gamma Table	Rg	Rn: Internal gamma resistor	0.7×Rn	1.0×Rn	1.3×Rn	ohm

7. RGB MODE AC ELECTRICAL CHARACTERISTICS

(Detail please refer IC data sheet)

Parameter	Symbol	Condition	Min.	Typ.	Max.	Unit
VDD Power On Slew rate	T _{POR}	From 0V to 90% VDD	-	-	20	ms
RSTB pulse width	T _{RST}	CLKIN = 50MHz	50	-	-	us
CLKIN cycle time	T _{cph}	-	20	-	-	ns
CLKIN pulse duty	T _{cwh}	-	40	50	60	%
VSD setup time	T _{vst}	-	8	-	-	ns
VSD hold time	T _{vhd}	-	8	-	-	ns
HSD setup time	T _{hst}	-	8	-	-	ns
HSD hold time	T _{hhd}	-	8	-	-	ns
Data set-up time	T _{dsu}	DR[7:0], DG[7:0], DB[7:0] to CLKIN	8	-	-	ns
Data hold time	T _{dhd}	DR[7:0], DG[7:0], DB[7:0] to CLKIN	8	-	-	ns
DEN setup time	T _{esu}	-	8	-	-	ns
DEN hold time	T _{ehd}	-	8	-	-	ns
Output stable time	T _{sst}	10% to 90% target voltage. CL=120pF, R=10K-ohm	-	-	6	us

8. Data input format for RGB

Parameter	Symbol	Value			Unit	Note
Horizontal display area	thd	800			DCLK	
DCLK frequency	fclk	Min.	Typ.	Max	MHz	thb+thpw=88 DCLK is fixed.
		20	33.3	50		
1 Horizontal Line	th	908	928	1088	DCLK	
HSD pulse width	thpw	1	48	87		
HSD Back Porch (Blanking)	thb	87	40	1		
HSD Front Porch	thfp	20	40	200		

Table 19. Vertical input timing

Parameter	Symbol	Min.	Typ.	Max.	Unit	Note
Vertical display area	tvd	480			H	
VSD period time	tv	517	525	712	H	tvpw+tvb=32H Is fixed
VSD pulse width	tvpw	1	1	3	H	
VSD Back Porch (Blanking)	tvb	31	31	29	H	
VSD Front Porch	tvfp	5	13	200	H	

9. Backlight Characteristic

Item	Symbol	Min	Typical	Max	Unit
LED module Forward voltage	V _{LED}	--	9.6	---	V
LED module current	I _{LED}	--	120	--	mA
L/G Surface Luminance ★1	L _s	--	tbd	--	mcd
LCM Surface brightness uniform ★2	L _D	80	--	--	%

★ 1 Test condition is:

- (a) Center point on active area.
- (b) Best Contrast.

★2 Uniform measure condition:

- (1) Measure 9 point. Measure location show below;
- (2) $\text{Uniform} = (\text{Min. brightness} / \text{Max. brightness}) * 100\%$
- (3) Best Contrast.

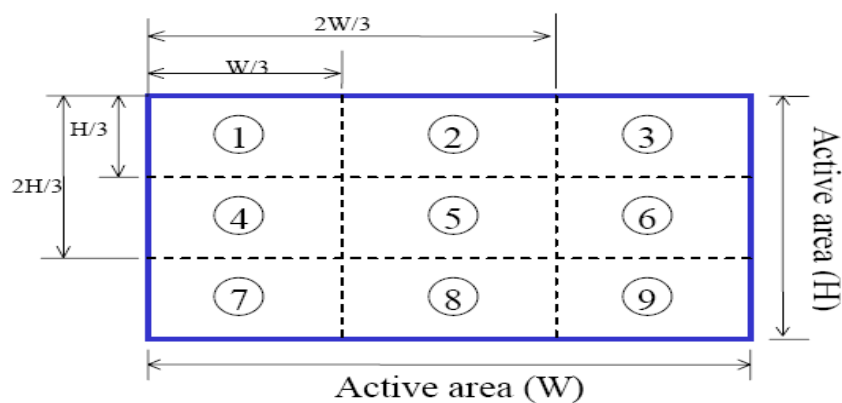

10. Electro-optical Characteristics

Parameter		Symbol	Condition	Min.	Typ.	Max.	Unit	Remark
Viewing angle range	Hor.	$\phi 3$	$CR \geq 10$	60	70		Deg.	
		$\phi 9$		60	70	Deg.		
	Ver.	$\phi 12$		40	50	Deg.		
		$\phi 6$		60	70	Deg.		
Color gamut (C light)				60			%	
Luminance Contrast ratio		T (%)	$\phi 0^\circ$	TBD	TBD			
Response Time		TRT	Temp=25° C		25		ms	

11. Reliability

11.1 Mtbf

The LCD module shall be designed to meet a minimum MTBF value of 50000 hours with normal

11.2 Test condition

NO.	ITEM	CONDITION	CRITERION
1	High Temperature Non-Operating Test	60°C*240Hrs	◦ No Defect Of Operational Function In Room Temperature Are Allowable
2	Low Temperature Non-Operating Test	-20°C*240Hrs	
3	High Temperature/Humidity Non Operating Test	60°C*90%RH*240Hrs	
4	High Temperature Operating Test	50°C*240Hrs	
5	Low Temperature Operating Test	-10°C*240Hrs	
6	Thermal Shock Test	-10 °C (30Min) ~50 °C (30Min) *10CYCLES	◦ IDD of LCM in Pre-and Post-Test Should Follow Specification

Notes:

1. Judgments should be made after exposure in room temperature for two hours.
2. The distill water is used for the high temperature/humidity test.
3. The sample above is individually for every reliability tests condition.

12. Inspection standards

1.AQL(Acceptable Quality Level

AQL of major and minor defect.

	MAJOR DEFECT	MINOR DEFECT
AQL	0.65	1.5

2. Basic conditions for inspection

The LCM face to us, in normal environment, the lux is 1000 ± 200 .(Darkroom's lux: 100 ± 50),About an angle of incidence 30,a distance of 30 cm with an angle of 45 degree to check the products without uncovering the film!

(As shown below)

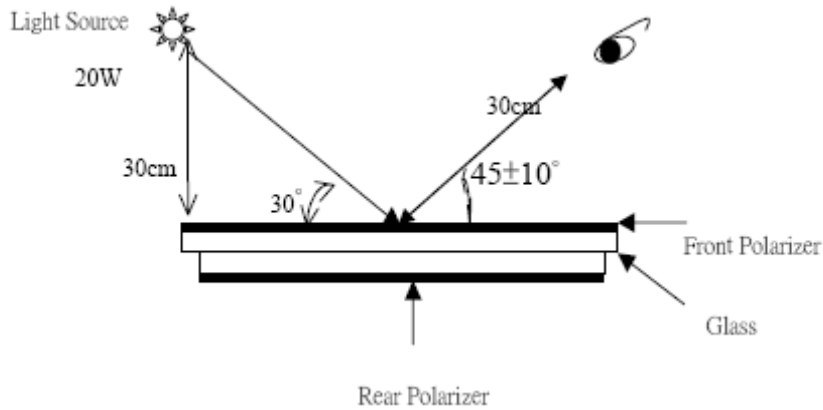

3. Inspection item and criteria

3.1 Visual inspection criterion in immobility

3.1 LCD appearance defect(View area)

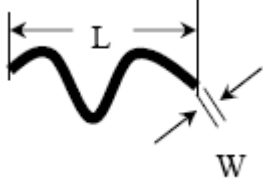
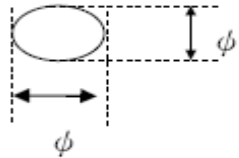
NO	Defect item	Criteria		Remark
		Specification	Allowable	
1	Fiber、 glass cratch、 polarizer scratch/folded (minor defect)	$W \leq 0.03\text{mm}$	disregard	note1:L: Length, W: Width note2: disregard if out of AA 
		$0.03\text{mm} < W \leq 0.05\text{mm};$ $L \leq 3.0\text{mm}$	2	
		$0.05\text{mm} < W \leq 0.1\text{mm};$ $L \leq 3.0\text{mm}$	1	
		$W > 0.1\text{mm}; L > 3.0\text{mm}$	0	
2	Polarizer bubble、 concave and convex (minor defect)	$\phi \leq 0.2\text{mm}$	disregard	note1: $\phi = (L+W)/2$, L:Length, W :Width note2:disregard if out of AA
		$0.2\text{mm} < \phi \leq 0.3\text{mm}$	2	
		$0.3\text{mm} < \phi \leq 0.5\text{mm}$	1	
		$0.5\text{mm} < \phi$	0	
3	Black dots、 dirty dots、 impurities、 eye winker (minor defect)	$\phi \leq 0.15\text{mm}$	disregard	note2:disregard if out of AA 
		$0.15\text{mm} < \phi \leq 0.25\text{mm}$	2	
		$0.25\text{mm} < \phi \leq 0.3\text{mm}$	1	
		$0.3\text{mm} < \phi$	0	
4	Polarizer prick (minor defect)	$\phi \leq 0.1\text{mm}$	disregard	note1: $\phi = (L+W)/2$, L=Length, W=Width note2:the distance between two dots>5mm
		$0.1\text{mm} < \phi \leq 0.25\text{mm}$	3	
		$\phi > 0.25\text{mm}$	0	

3.2Electrical criteria

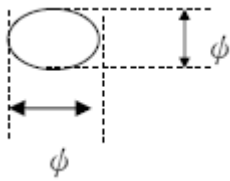
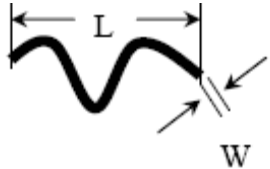
NO	Defect item	Criteria	Remark	
1	No display (major defect)	No display 【Reject】		
2	Missing line (major defect)	Missing line 【Reject】		
3	Seg-com light and dark (major defect)	Seg-com light and dark 【Reject】	ND filter 2% test	
4	No display in immobility (major defect)	No display in immobility 【Reject】		
5	Flicker of Pattern (major defect)	Flicker of Pattern 【Reject】		
6	Mura (major defect)	ND filter 2% test		
7	Over current (major defect)	Over current 【Reject】		
8	Voltage out of specification (major defect)	Voltage out of specification 【Reject】		
9	Pattern blur, error code (major defect)	Pattern blur, error code 【Reject】		
10	Dark light, Flicker (major defect)	Dark light, Flicker 【Reject】		
11	Black/white dots 、 Dirty dots、 eye winker (major defect)	Specification	Allowable	Note1:disregard if out of AA 
		$\phi \leq 0.15\text{mm}$	disregard	
		$0.15\text{mm} < \phi \leq 0.25\text{mm}$	2	
		$0.25\text{mm} < \phi \leq 0.3\text{mm}$	1	
		$0.3\text{mm} < \phi$	0	
12	Fiber、glass crutch、Polarizer scratch/folded (major defect)	$W \leq 0.03\text{mm}$	disregard	Note1:L: Length, W: Width Note2: disregard if out of AA 
		$0.03\text{mm} < W \leq 0.05\text{mm}$ $L \leq 3.0\text{mm}$	2	
		$0.05\text{mm} < W \leq 0.1\text{mm}$ $L \leq 3.0\text{mm}$	1	
		$W > 0.1\text{mm}; L > 3.0\text{mm}$	0	

13. Precautions for using LCD modules.

13.1 Safety

- (1) Do not swallow any liquid crystal, even if there is no proof that liquid crystal is poisonous.
- (2) If the LCD panel breaks, be careful not to get liquid crystal to touch your skin.
- (3) If skin is exposed to liquid crystal, wash the area thoroughly with alcohol or soap.

13.2 Storage Conditions

- (4) Store the panel or module in a dark place where the temperature is $23 \pm 5^\circ\text{C}$ and the humidity is below $45 \pm 20\% \text{RH}$.
- (5) Store in anti-static electricity container.
- (6) Store in clean environment, free from dust, active gas, and solvent.
- (7) Do not place the module near organics solvents or corrosive gases.
- (8) Do not crush, shake, or jolt the module.

13.3 Handling Precautions

- (9) Avoid static electricity, which can damage the CMOS LSI.
- (10) The polarizing plate of the display is very fragile, please handle it very carefully.
- (11) Do not give external shock.
- (12) Do not apply excessive force on the surface.
- (13) Do not wipe the polarizing plate with a dry cloth, as it may easily scratch the surface of plate.
- (14) Do not use ketonic solvent & Aromatic solvent, use with a soft cloth soaked with a cleaning naphtha solvent.
- (15) Do not operate it above the absolute maximum rating.
- (16) Do not remove the panel or frame from the module.

13.4 Warranty

The period is within twelve months since the date of shipping out under normal using and storage conditions.
