

**Fukui (HK) CO., Limited**

**Product Specification**  
**产品规格书**

**HK-035Q35-50**

**3.5" 800(H)\*3(RGB)\*480(V) TFT LCD MODULE**

May 19, 2018

Customer: \_\_\_\_\_

Customer Approval and Feedback

**LONGCHI Signature:**

Prepared by	Checked by	Approved by
ZHH	XZ	YXN

## Table of Contents

<b>REVISION HISTORY</b> .....	<b>3</b>
<b>1. GENERAL DESCRIPTION</b> .....	<b>4</b>
1.1 DESCRIPTION.....	4
1.2 GENERAL INFORMATION.....	4
<b>2. ABSOLUTE MAXIMUM RATING</b> .....	<b>5</b>
<b>3. ELECTRICAL CHARACTERISTICS</b> .....	<b>6</b>
3.1 LCM DC CHARACTERISTICS.....	6
3.2 BACK-LIGHT UNIT CHARACTERISTICS.....	6
<b>4. OPTICAL CHARACTERISTICS</b> .....	<b>7</b>
<b>5. MODULE OUTLINE DIMENSION</b> .....	<b>10</b>
<b>6. MODULE INTERFACE DESCRIPTION</b> .....	<b>11</b>
<b>7. REFERENCE APPLICATION CIRCUIT</b> .....	<b>11</b>
<b>8. TIMINGS FOR RGB Interface</b> .....	<b>12</b>
<b>9. RELIABILITY TEST CONDITIONS</b> .....	<b>15</b>
<b>10. PACKING</b> .....	<b>15</b>
<b>11. INSPECTION CRITERION</b> .....	<b>16</b>
<b>12. GENERAL PRECAUTIONS</b> .....	<b>19</b>



## 1. GENERAL DESCRIPTION

### 1.1 DESCRIPTION

FJ035WV05-V0-50PIN is a transmissive type color active matrix TFT (Thin Film Transistor) liquid crystal display (LCD) that uses amorphous silicon TFT as a switching device. This model is composed of a TFT-LCD module (TFT-LCD panel, driver IC and FPC), a back-light unit and. The resolution of 3.5" contains 800RGBX480 pixels and can display up to 16.7M colors.

### 1.2 GENERAL INFORMATION

Items	Specification	Unit	Note
Display mode	TFT Transmissive, Positive, NW, TN	-	-
Drive element	a-Si TFT active matrix	-	-
LCM outline size	87.1(H) x 56.8(V) x 2.75(T)	mm	Note (1)(2)
Active area	77.59H)X43.65(V)	mm	-
Number of pixels	800*3RGB(H)X480(V)	pixels	-
Pixel arrangement	RGB stripe	-	-
Pixel size	0.03233*3(W) x 0.09093 (H)	mm	-
Display color	262k	color	-
Viewing direction	6 O'CLOCK	-	-
Controller / Driver	-	-	-
Data interface	24 BIT RGB Interface	-	-
Backlight	6 White LEDs In Series	-	-
Weight	TBD	g	-

Notes:

- (1) Touch panel and back-light unit are included.
- (2) FPC no included. (Refer to the module outline dimension for further information). Please see module specification drawing in Page14 for more details.

## 2. ABSOLUTE MAXIMUM RATING

(Ta=25±2°C, Vss=GND=0V)

Characteristics	Symbol	Min.	Max.	Unit	Notes
Power Supply Voltage 1	VDD1	-	-	V	
Power Supply Voltage 2	VDD2	-	-	V	
Power Supply Voltage 3	VDD3	-	-	V	
Power Supply Voltage 4	HS_VCC	-	-	V	
Power Supply Voltage 5	VSP	-	-	V	
Power Supply Voltage 6	VSN	-	-	V	
TFT Gate On voltage	VGH	12	+19	V	
TFT Gate Off voltage	VGL	-7.0	-10	V	
Logic Signal Input Voltage	V <sub>IN</sub>	-0.3	VDD1+0.3	V	
HS Input Voltage	V <sub>IN</sub>	-0.3	+2.0	V	
Backlight Forward Current	I <sub>F</sub>	-	20	mA	
Operating Temperature	T <sub>OPR</sub>	-20	+70	°C	(1), (3)
Storage Temperature	T <sub>STG</sub>	-30	+80	°C	(2), (3)
Humidity	RH	-	90	%	Max. 60 °C

### Notes:

- (1) In case of below 0°C, the response time of liquid crystal (LC) becomes slower and the color of panel becomes darker than normal one. Level of retardation depends on temperature, because of the LC characteristics.
- (2) If product is exposed to high temperatures for extended time, there is a possibility of the polarizer film damage which could degrade the optical characteristics.
- (3) Permanent damage to the device may occur if maximum values are exceeded or reverse voltage is loaded.  
Functional operation should be restricted to the conditions described under normal operating conditions.

### 3. ELECTRICAL CHARACTERISTICS

#### 3.1 LCM DC CHARACTERISTICS

(Ta=25±2°C)

Characteristics	Symbol	Min.	Typ.	Max.	Unit	Note
Power Supply Voltage 1	VDD	3	3.3	3.6	V	
Power Supply Voltage 2	AVDD	10	9.6	10.6	V	
Common Power Supply Voltage	VCOM	3.2	3.86	4.1	V	
Gate Driver High voltage	VGH	17	18	19	V	
Gate Driver Low voltage	VGL	-9	-6	-5	V	
Current Consumption	I <sub>DD</sub>	-	TBD	-	mA	Normal mode
	I <sub>DD-SLEEP</sub>		TBD		uA	Sleep mode
Input voltage "L" Level	V <sub>IL</sub>	GND	-	0.3VDD	V	VDD1=1.65~3.6
Input voltage "H" Level	V <sub>IH</sub>	0.7VDD	-	VDD	V	
Output voltage "L" Level	V <sub>oL</sub>	-	-	GND+0.4	V	I <sub>oL</sub> =1mA
Output voltage "H" Level	V <sub>oH</sub>	VDD-0.4	-	-	V	I <sub>oH</sub> =-1mA

#### 3.2 BACK-LIGHT UNIT CHARACTERISTICS

The back-light system is an edge-lighting type with 7 white LEDs. The characteristics of the back-light are shown in the following tables.

(Ta=25±2°C)

Characteristics	Symbol	Condition	Min.	Type	Max.	Unit	Notes
Forward Voltage	V <sub>f</sub>	I <sub>L</sub> =20mA	8.7	9.6	10.5	V	-
Forward current	I <sub>L</sub>		--	120	-	mA	-
Luminance	L <sub>v</sub>	I <sub>L</sub> =20mA	TBD	TBD	--	cd/m <sup>2</sup>	-
LED life time	-	I <sub>L</sub> =20mA	10,000	20,000	--	Hr	Note 1

Note:

- (1) The "LED life time" is defined as the module brightness decrease to 50% of original brightness at I<sub>L</sub>=20mA. The LED life time could be decreased if operating I<sub>L</sub> is larger than 20mA.

Backlight circuit diagram shown in below:

6串1并 I=20mA

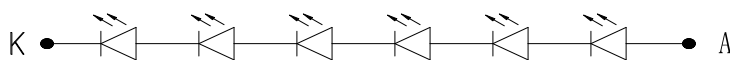

产品电路原理图

## 4. OPTICAL CHARACTERISTICS

The following items are measured under stable conditions. The optical characteristics should be measured in a dark room.

Measuring equipment: BM-5AS, BM-7, EZ-Contrast.

(Ta=25±2°C)

Parameter		Symbol	Condition	Min.	Typ.	Max.	Unit	Note
Contrast Ratio (Center point)		C/R	-	-	500	-	-	BM-7 Note(2)
Luminance of white (Center point)		L <sub>w</sub>	B/L on	400	450	-	cd/m <sup>2</sup>	BM-7
Luminance uniformity		U <sub>w</sub>	θ = 0. Normal viewing angle B/L On  Note(1)	80	-	-	%	BM-7 Note(3)
Response Time		Tr + Tf		-	25	-	ms	BM-5AS Note(4)
Color Chromaticity (CIE 1931)	White	W <sub>x</sub>	θ = 0. Normal viewing angle B/L On  Note(1)	-0.05	0.297	+0.05	-	BM-7 Note(5)
		W <sub>y</sub>		-0.05	0.311	+0.05		
	Red	R <sub>x</sub>		-0.05	0.555	+0.05		
		R <sub>y</sub>		-0.05	0.324	+0.05		
	Green	G <sub>x</sub>		-0.05	0.354	+0.05		
		G <sub>y</sub>		-0.05	0.601	+0.05		
	Blue	B <sub>x</sub>		-0.05	0.146	+0.05		
		B <sub>y</sub>		-0.05	0.072	+0.05		
Viewing Angle	Hor.	θ <sub>L</sub>	C/R≥10	-	70	-	Deg	EZ Contrast Note(6)
		θ <sub>R</sub>		-	70	-		
	Ver.	θ <sub>u</sub>		-	60	-		
		θ <sub>D</sub>		-	70	-		
Optima View Direction			6 :00				Note(7)	

\* This condition will be changed by the evaluation circumstance. If product is exposed to high temperatures for extended time, there is a possibility of the polarizer film damage which could degrade the optical characteristics.

Notes:

- (1) Test Equipment Setup: After stabilizing and leaving the panel alone at a given temperature for 30min, the measurement should be executed. Measurement should be executed in a stable, windless, and dark room 30min after lighting the back-light. This should be measured in the center of screen.

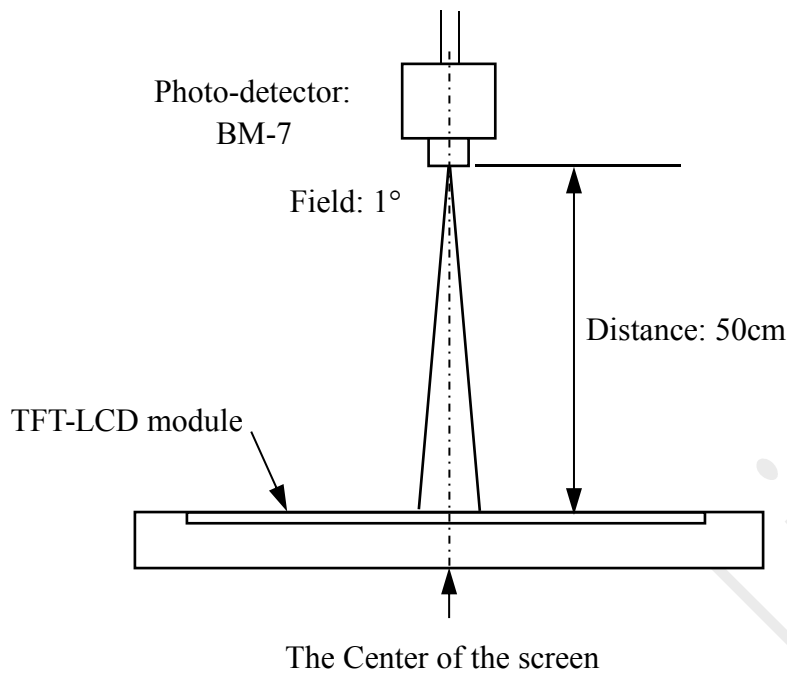

(2) Definition of Contrast Ratio (CR):

$$\text{Contrast Ratio (CR)} = \frac{\text{Luminance measured when LCD on the "white" state}}{\text{Luminance measured when LCD on the "black" state}}$$

(3) Definition of Luminance Uniformity: Active area is divided into 9 measuring areas (Shown in below), every measuring point is placed at the center of each measuring area.

$$\text{Luminance Uniformity} = \frac{\text{Min Luminance of white among 9-points}}{\text{Max Luminance of white among 9-points}} \times 100\%$$

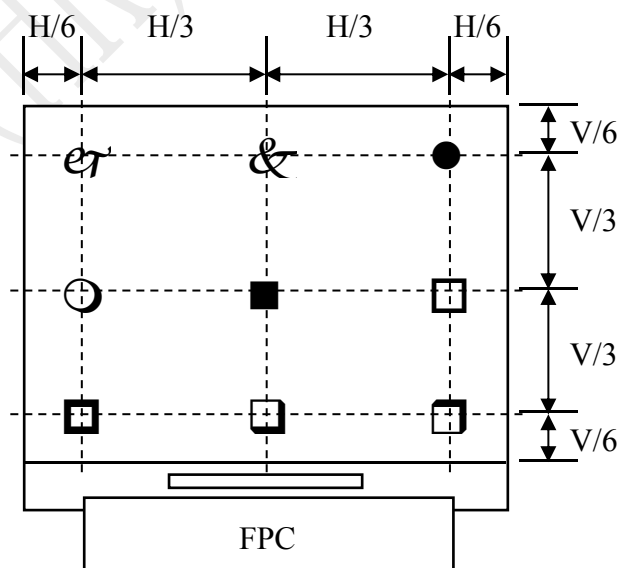

The spot locations for luminance measurement



- (4) Definition of Response time: Sum of  $T_r$  and  $T_f$ .

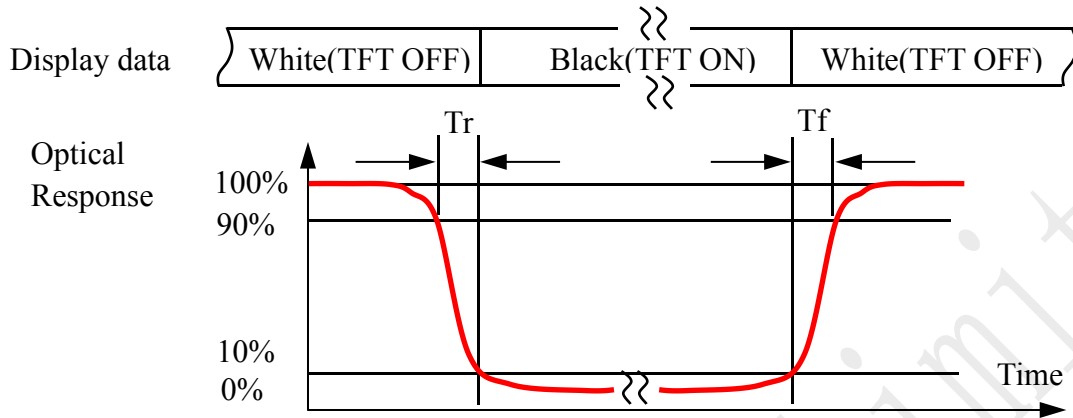

- (5) Definition of Viewing Angle: The viewing angle range that the  $CR \geq 10$ .

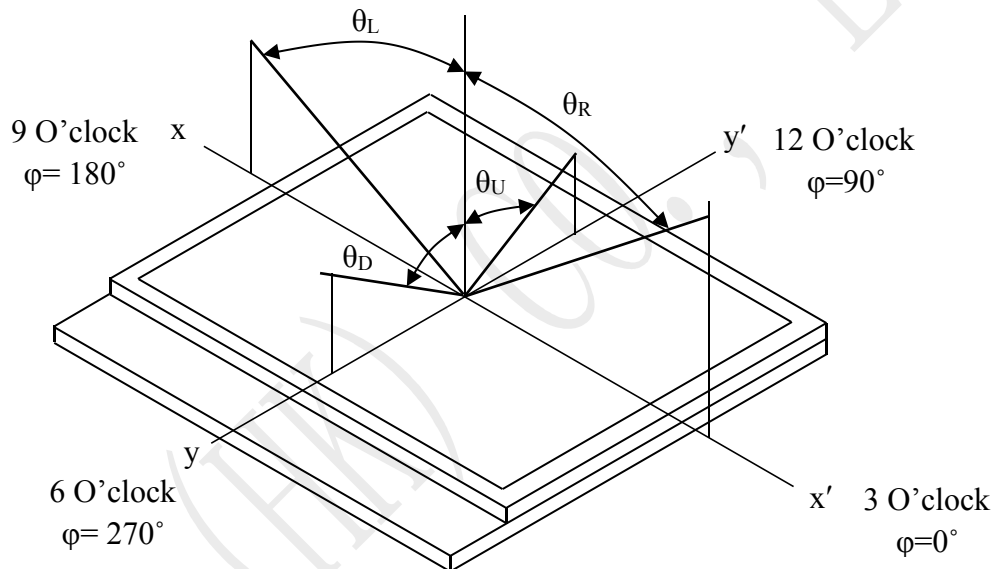

- (6) Definition of Color Chromaticity (CIE 1931)  
Color coordinate of white & red, green, blue at center point.
- (7) The different Rubbing Direction will cause the different optima view direction.

## 5. MODULE OUTLINE DIMENSION

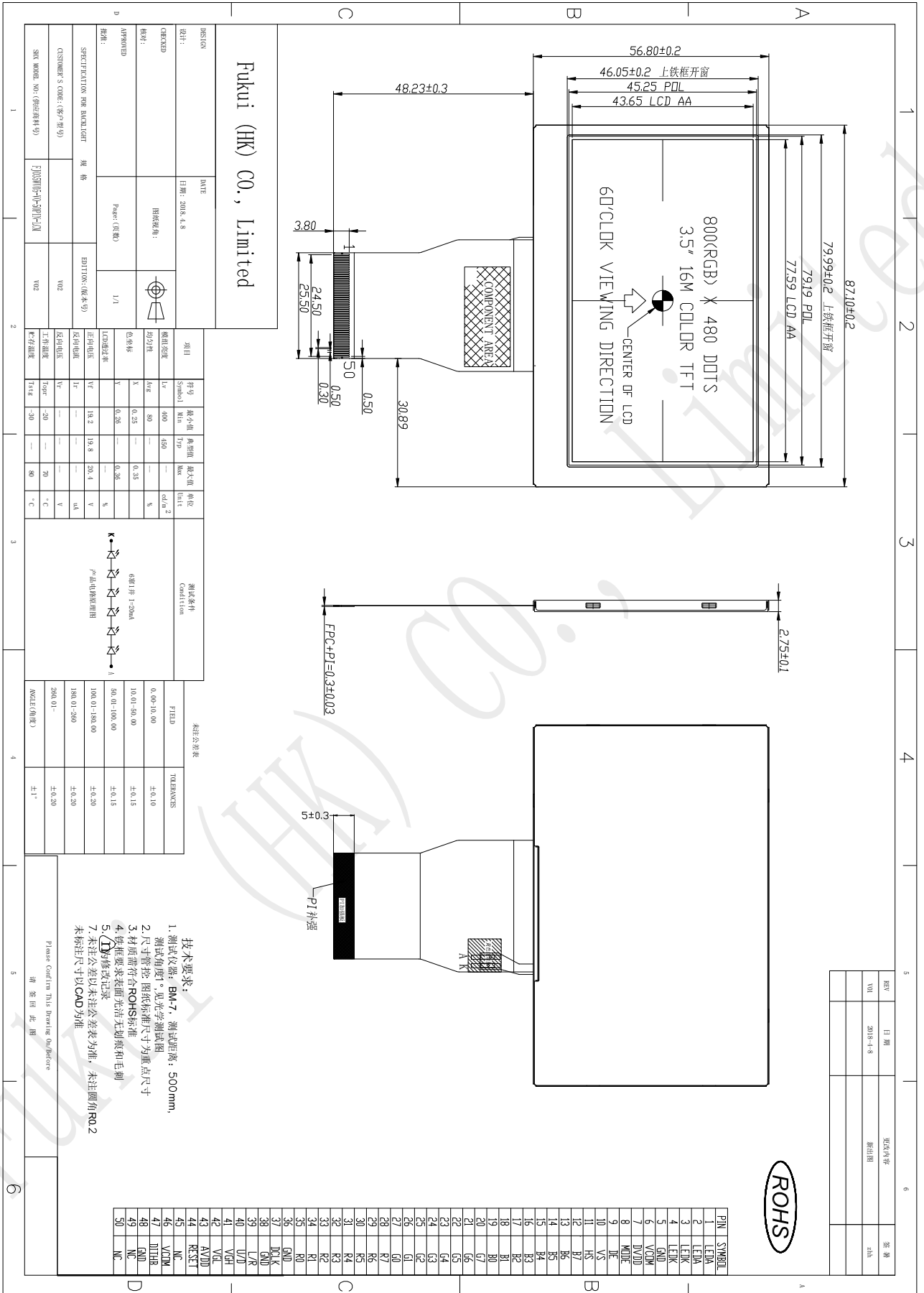

## 6. MODULE INTERFACE DESCRIPTION

Pin No.	Symbol	I/O	Description	Note
1~2	LED+	P	LED Anode	
3~4	LED-	P	LED Cathode	
5	GND	P	Ground	
6	VCOM	P	Common Power Supply	
7	DVDD	P	Power supply	
8	MODE	I	DE/SYNC mode select,H:DE mode; L:SYNC mode	
9	DE	I	Data enable signal	
10	VS	I	Vertical sync input.Negative polarity.	
11	HS	I	Horizontal sync input.Negative polarity.	
12~19	B7~B0	I/O	Blue Data input	
20~27	G7~G0	I/O	Green Data input	
28~35	R7~R0	I/O	Red Data input	
36	GND	P	Ground	
37	DCLK	I	Clock input	
38	GND	P	Ground	
39	L/R	I	Left or Right Display Control	
40	U/D	I	Up and Down Display Control	
41	VGH	P	Positive Power for TFT	
42	VGL	P	Negative Power for TFT	
43	AVDD	P	Analog Power	
44	RESET	I	Global reset pin.	
45	NC	-	NC	
46	VCOM	P	Common Power Supply	
47	ITHB	I	Dithering function enable control.	
48	GND	P	Ground	
49	NC	-	NC	
50	NC	-	NC	

## 7. REFERENCE APPLICATION CIRCUIT

Please consult our technical department for detail information.

## 8. TIMINGS FOR 24-bit RGB Interface

### 8.1 SYNC Mode Timing Diagram

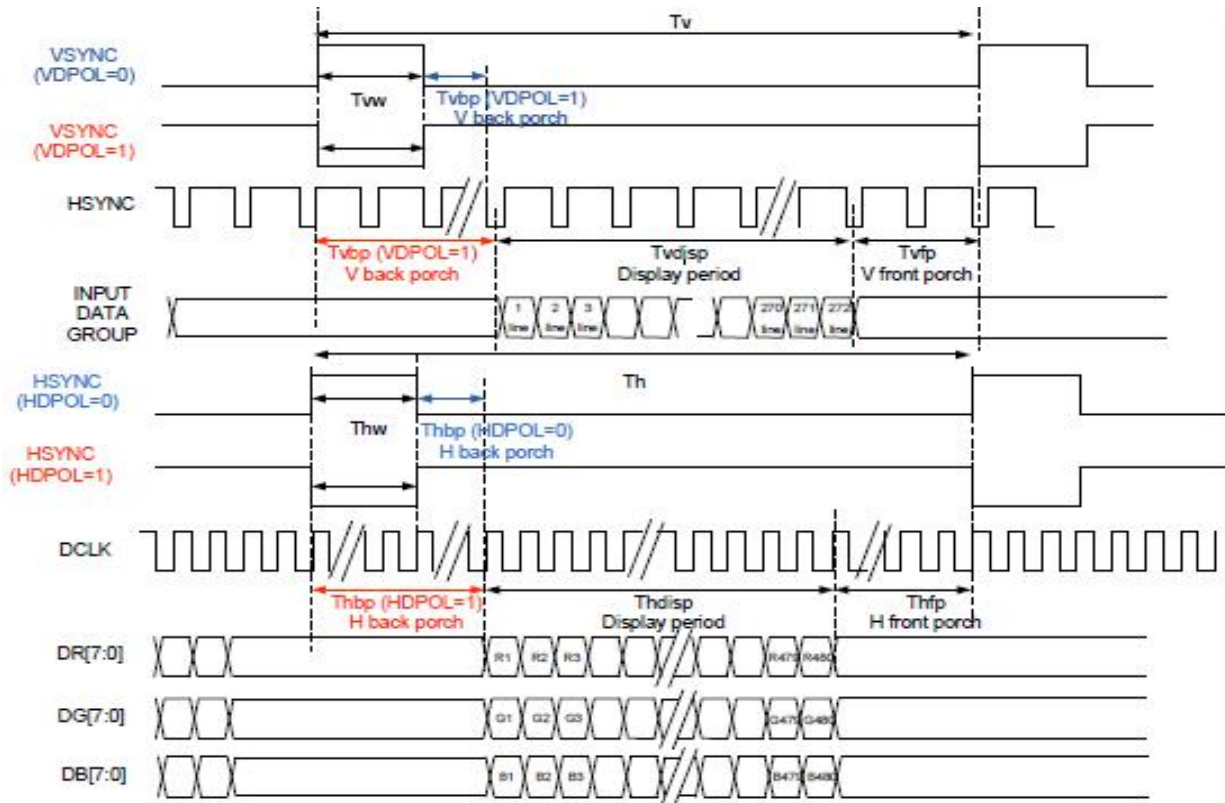

### 8.2 SYNC-DE Mode Timing Diagram

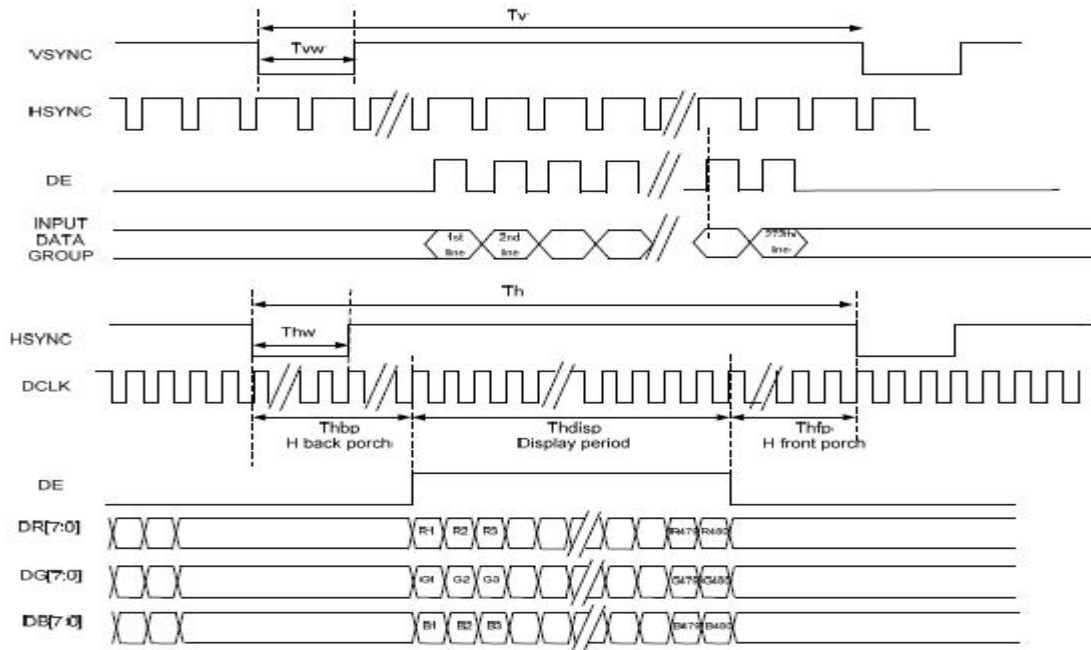

EK79001H+EK73002A						
Parameter	Symbol	Value			Unit	
		Min.	Typ.	Max.		
Frame Rate	-	60			Hz	
DCLK Frequency	$F_{DCLK}$	27.7	29.2	39.6	MHz	
Horizontal	Total line	$t_H$	900	928	1100	DCLK
	Active pixels	$t_{Hac}$	800			DCLK
	Back porch	$t_{HBP}$	88			DCLK
	Pulse width	$t_{HWP}$	1	-	40	DCLK
	Front porch	$t_{HFP}$	12	40	212	DCLK
Vertical	Total time	$t_V$	513	525	600	H
	Active lines	$t_{Vac}$	480			H
	Back porch	$t_{VBP}$	32			H
	Pulse width	$t_{VWP}$	1	-	3	H
	Front porch	$t_{VFP}$	1	13	88	H

## 9. RELIABILITY TEST CONDITIONS

No.	Test Item	Test Condition	Notes
1	High Temperature Storage	+80°C / 120H	Inspection after 2~4h storage at room temperature, the sample shall be free from defects: 1. Air bubble in the LCD; 2. Seal leak; 3. Non-display; 4. Missing segments; 5. Glass crack; 6. The surface shall be free from damage. 7. The electrical characteristics requirements shall be satisfied.
2	Low Temperature Storage	-30°C / 120H	
3	High Temperature Operating	+70°C / 120H	
4	Low Temperature Operating	-20°C / 120H	
5	Temperature Cycle	0±2°CΔ25°CΔ+50±2°C x 10cycles (30min) (5min) (30min)	
6	High Temperature /Humidity storage	50+5°C x 90%RH / 120H	
7	Vibration Test	Frequency: 10Hz~55Hz~10Hz Amplitude:1.5mm, 2 hours for each direction of X, Y, Z	
8	Packing Drop Test	Drop to the ground from 1m height, 1 corner, 3 edges, 6 surfaces.	
9	ESD test	Voltage:±8KV R: 330Ω C: 150pF Air discharge, 10time	

**Remarks:**

- (1) The test samples should be applied to only one test item.
- (2) Sample size for each test item is 5~10pcs.
- (3) For High Temperature/Humidity storage test, pure water (resistance>10MΩ) should be used.
- (4) In case of malfunction defect caused by ESD damage, if it would be recovered to normal state after resetting, it would be judge as a good part.
- (5) Failure judgment criterion: basic specification, electrical characteristic, mechanical characteristic, optical characteristic.

**10. PACKING SPECIFICATION**



TBD.

**11. INSPECTION CRITERION**

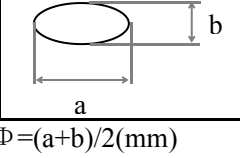
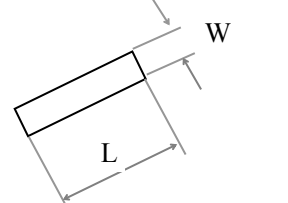
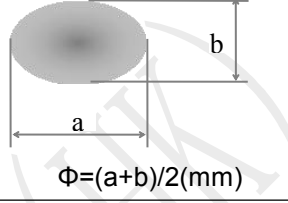
Inspection item	Judgement standard		
	Category	Acceptable number	
		A zone	B zone

1	Black spot, White spot, Bright Spot, Pinhole Foreign Particle, Bubble and Particle Between polarizer and glass, scratch on polarizer		A B C D	$\Phi \leq 0.15$ $0.15 < \Phi \leq 0.20$ $0.20 < \Phi \leq 0.30$ $0.30 < \Phi$	Ignored 2 1 0	Ignored	
			Total defective point(B,C)		3		
	Pixel point defect	Bright spot			$0.15 < \Phi \leq 0.20$	$N \leq 0$	Ignored
		Dark spot/ Black spot			$0.15 < \Phi \leq 0.20$	$N \leq 2$	
		Attached to the two pixels are bright spots			$0.15 < \Phi \leq 0.20$	$N \leq 0$	
		Even a two pixel is dark			$0.15 < \Phi \leq 0.20$	$N \leq 0$	
Pixel total number				$0.15 < \Phi \leq 0.20$	$N \leq 2$		
		Note1: the spot defect caused by foreign matter is judged according to the defect of the foreign body. Note 2: when the light is not wired to show the type of defects.					
2	Black line, White line, Bubble and Particle Between Polarizer and glass, Scratch on polarizer	 W:Width, L:Length(mm)	A B C D	$W \leq 0.10$ $0.01 < W \leq 0.03 \quad L \leq 3.0$ $0.03 < W \leq 0.05 \quad L \leq 3.0$ $0.05 < W$	Ignored 2 1 0	Ignored	
			Total defective point(B,C)		2		
3	Contrast variation		A B C D	$\Phi \leq 0.2$ $0.2 < \Phi \leq 0.3$ $0.3 < \Phi \leq 0.4$ $0.4 < \Phi$	Ignored 2 1 0	Ignored	
			Total defective point(B,C)		3		
4	Bubble inside cell			any size	none	none	
5	Polarizer defect (if Polarizer is used)	Scratch and damage on polarizer, particle on polarizer or between polarizer and glass.	Refer to item 1 and item 2.				
		Bubble, dent and convex	A B C	$\Phi \leq 0.3$ $0.3 < \Phi \leq 0.7$ $0.7 < \Phi$	Ignored 2 0	Ignored	
		Total defective point(B,C)		2			

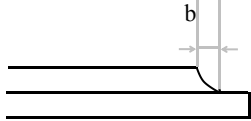
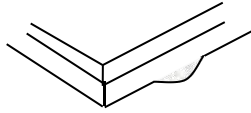
Inspection item	Judgement standard		
	Category	Acceptable number	
		A zone	B zone

6	Surplus glass	①Stage surplus glass 	$b \leq 0.3\text{mm}$
		②Surrounding surplus glass 	Should not influence outline dimension and assembling.
7	MURA	①MURA	Naked eye examination: red, green, blue screen does not allow the appearance, black screen requires visual is not obvious, the specific reference limit samples. Note: the principle of closing the sample is to be installed on the whole machine and the end user will not find it in the normal usage scenario. Inspection basis: 6%ND (MURA mainly in the black screen and indoor light is relatively dark will be found, it is recommended to turn off the indoor lighting inspection.)
		②Point Black / White / point(MURA)	1, under the black / gray screen check: $D \leq 0.10\text{mm}$ Ignored; $0.10\text{mm} < D \leq 0.3\text{mm}$ , $N \leq 2$ ; $D > 0.3\text{mm}$ : Unqualified. 2, switch to the red, green, blue in which any one of the screen appears black or white or point to point white or point of failure. 

Inspection item		Judgment standard	
		Category(application: B zone)	
8	Glass	①The front of lead terminals	A If $a \leq t$ and $b \leq 1.0$ , $c$ is not limited



defect crack		B	$a \leq t, 1 \leq b \leq 2\text{mm}, c \leq 3\text{mm}$
		C	If glass crack cover alignment mark, $b \leq 0.5\text{mm}$ .
		D	Crack at two sides of lead terminals should not cover patterns and alignment mark
	<p>② Surrounding crack—non-contact side</p> <p><u>Inner border line of the seal</u> <u>Outer border line of the seal</u></p>	$b < \text{Inner borderline of the seal}$	
<p>③ Surrounding crack—contact side</p> <p><u>Inner border line of the seal</u> <u>Outer border line of the seal</u></p>	$b < \text{Outer borderline of the seal}$		
<p>④ Corner</p>	A	$a \leq t, b \leq 3.0, c \leq 3.0$	
	*Glass crack should not cover patterns used for		

Inspection item	Judgement standard
-----------------	--------------------

9	FPC defect	<p>Component soldering: No cold soldering, short/open circuit, burr, tin ball.</p> <p>The flat encapsulation component position deviation must be less than 1/2 width of the pin (Pic.1):</p> <p>The sheet component deviation: pin deviates from the pad and contact with the near components is not permitted (Pic.2)</p>	
		<p>lead defect:</p> <p>The lead lack must be less than 1/2 of its width;</p> <p>The lead burr must be less than 1/2 of the seam;</p> <p>Impurities connect with the near leads is not permitted</p>	
		<p>Connector soldering:</p> <p>Soldering tin is at contact position of the plug and socket is not permitted</p> <p>No foundation is scald</p> <p>Serious cave distortion on plug and socket contact pin is not permitted</p>	

## 12. GENERAL PRECAUTIONS

## 1.1 HANDING

- (1) When the module is assembled, it should be attached to the system firmly. Be careful not to twist and bent the module.
- (2) Refrain from strong mechanical shock and / or any force to the module. In addition to damage, this may cause improper operation or damage to the module and back-light unit.
- (3) Note that display modules are very fragile and could be easily damaged. Do not press or scratch the surface harder than a HB pencil lead.
- (4) Wipe off water droplets or oil immediately. If you leave the droplets for a long time, straining and discoloration may occur.
- (5) If the display module surface becomes contaminated, breathe on the surface and gently wipe it with a soft dry cloth. If it is heavily contaminated, should be wiped by moisten cloth with isopropyl alcohol or ethyl alcohol solvents, DO NOT with water, ketone type materials (e.g. acetone), aromatic, toluene, ethyl acid or methyl chloride, and so on.
- (6) If the liquid crystal material leaks from the panel, it should be kept away from the eyes or mouth. In case of contact with hands, legs or clothes, it must be washed away thoroughly with soap.
- (7) Use finger-stalls with sort gloves in order to keep display clean during the incoming inspection and assembly process.
- (8) Protection film for polarizer on the module shall be slowly peeled off just before use so that the electrostatic charge can be minimized.
- (9) Do not touch directly conductive parts such as the CMOS LSI pad and the interface terminals with bare hands, therefore operations should be grounded whenever he/she comes into contact with the modules.
- (10) Do not exceed the absolute maximum rating value. (The supply voltage variation, input voltage variation, variation in part contents and environmental temperature, and so on), otherwise the module may be damaged.

## 1.2 SOLDERING

- (1) Use soldering irons with proper grounding and no leakage.
- (2) For No RoHS Product: soldering temperature is 290~350°C, soldering time is 3~5s; for RoHS Product: soldering temperature is 340~370°C, soldering time is 3~5s.
- (3) If soldering flux is used, be sure to remove any remaining flux after soldering (This does not apply in the case of a non-halogen type of flux).

## 1.3 STORAGE

- (1) DO NOT leave the module in high temperature and high humidity for a long times, keep the temperature from 0°C to 35°C and relative humidity of less than 60%.
- (2) It is highly recommended to store the module in a dark place. The Liquid crystal is deteriorated by ultraviolet, DO NOT leave it in direct sunlight and strong ultraviolet ray for many hours.
- (3) The polarizer surface should not come in contact with any other objects.